

# Code Practice Oscillator

from *ARRL Now You're Talking*, pp. 11-1 to 11-2

Copyright © 1990 by the American Radio Relay League, Inc. All rights reserved

## Assembling a Code-Practice Oscillator

It isn't difficult to construct a code-practice oscillator. A complete oscillator that mounts on a small piece of wood is shown in Figure A. Figure B shows all the parts for this project laid out ready for assembly. The circuit board for this project can be ordered from FAR Circuits, 18 N. 640 Field Court, Dundee, IL 60118-9269. A complete parts kit, including circuit board, is available from the Hoosier Lakes Amateur Radio Club, PO Box 981, Warsaw, IN 46581-0981

Contact these vendors for the latest pricing.

Please read all instructions carefully before mounting any parts. Check the parts-placement diagram for the location of each part.

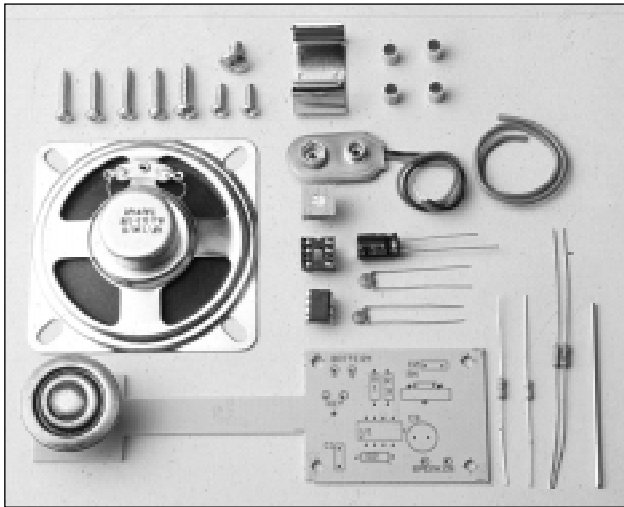

Figure A

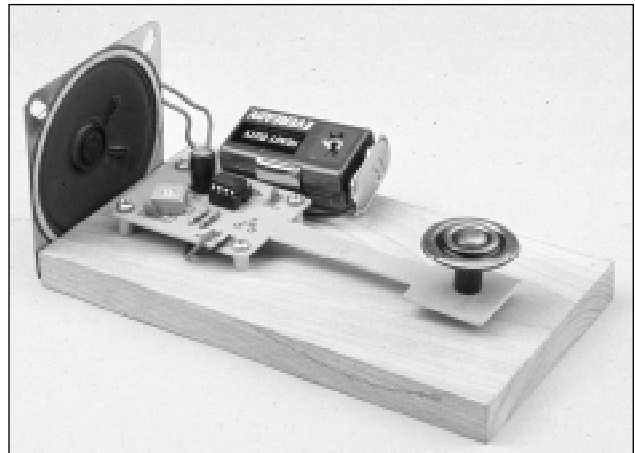

Figure B

- Check each box as that part is installed and soldered.

### Quantity Description

#### Capacitors

- 1 0.01- $\mu$ F
- 1 0.01- $\mu$ F
- 1 220- $\mu$ F, 35-V electrolytic

#### Resistors

- 1 10-kilohm,  $\frac{1}{4}$  W (brown-black-orange stripes)
- 1 47-kilohm,  $\frac{1}{4}$  W (yellow-violet-orange stripes)
- 1 10-kilohm,  $\frac{1}{4}$  W (brown-black-orange stripes)
- 1 47-ohm,  $\frac{1}{4}$  W (yellow-violet-black stripes)

#### Miscellaneous

- 1 100-kilohm potentiometer
- 1 8-pin IC socket
- 1 7555 CMOS Timer IC (or 555 Timer IC)
- 1 Loudspeaker — 2-inch, 8-ohm
- 1 Six to 10 inches of insulated wire, about 18 or 22 gauge
- 1 9-V battery connector
- 1 9-V battery
- 1 U-shaped battery holder
- 1 Brass rod, 2 inches long, approximately 18 gauge (about the diameter of a coat hanger). Available at hobby shops.
- 4  $\frac{1}{4}$ -inch spacers
- 1  $2 \times 4 \times \frac{1}{2}$ -inch piece of wood for base
- 5 No. 6 wood screws,  $\frac{3}{4}$ -inch long
- 2 No. 6 wood screws,  $\frac{3}{8}$ -inch long
- 1 Five-lug tie point, used to mount speaker (optional)

### Radio Shack Part Number

- 272-131
- 272-131
- 272-1029

### Component Number

- C1
- C2
- C3

### Used in Step Number

- 3
- 6
- 5

- 272-1335
- 272-1342
- 272-1335
- 271-009

- R2
- R3
- R1
- R5

- 4
- 8
- 9
- 11

- 271-284
- 276-1995
- 276-1718
- 40-245
- 270-325
- 23-553
- 270-326

- R4
- U1
- LS1

- 7
- 2
- 13
- 11

- BT1

- 10
- 10
- 12

- 64-3024
- 274-688

- 12
- 12
- 12
- 12
- 11

Assembly instructions

☐ Check each box as that step is completed.

☐ Step 1: Attach the brass rod. Check the parts-placement diagram (Figure E) for location.

Clean the brass rod with sandpaper or steel wool. Bend one end of the rod slightly less than 90 degrees. Lay the circuit board on the table with foil side up. Place the hooked end of the brass rod over the large hole near the handle (see Figure D). Make sure the rod extends out over the handle area. Solder the rod to the board on the foil side. The end of the brass rod should not extend past the marked oval on the handle. This is your contact point. If it does extend beyond this point, cut the rod off just before the end of the oval.

☐ Step 2: Solder the IC socket to the board.

The socket for the IC is placed on the component (non-foil) side of the board first. Do not plug the IC into the socket now. After all the other parts are soldered to the board you will be instructed to plug the IC into the socket (Step 13). Identify the notched end of the socket. Insert the socket into the circuit board. Turn the board over and gently spread the pins on the socket so they make contact with the foil side of the board. Solder the socket in place.

☐ Step 3: Place C1 (0.01- $\mu\text{F}$  capacitor) on the component side of the board.

Thread the wire leads on C1 through the holes on the board. (See Figure F.) Solder the wires onto the foil side of the board. Cut the extra wire off above the solder joint.

☐ Step 4: Place R2 (10-kilohm resistor) on the component side of the board.

Prepare resistors for mounting by bending each lead (wire) of the resistor to approximately a 90° angle. (See Figure G.) Insert the leads into the board holes and bend them over to hold the resistor in place. Solder the leads to the foil and trim them close to the foil.

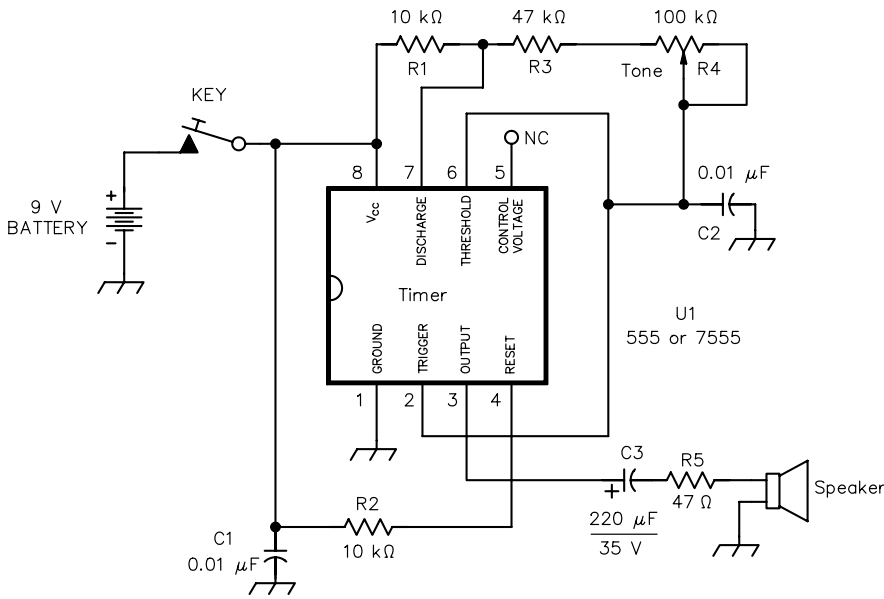

☐ Step 5: Place C3 (220- $\mu\text{F}$ , 35-volt electrolytic capacitor) on the component side of the board.

This capacitor has a plus (+) side and a negative (-) side. The (-) side is placed on the board facing away from the handle. (Notice the + sign printed on the circuit board at this location.) Insert the capacitor leads into the circuit board holes, solder them in place and trim off the extra wire.

☐ Step 6: Place C2 (0.01- $\mu\text{F}$  capacitor) on the component side of the board.

Thread the wire leads from C2 through the holes on the circuit board. (See Step 3 and Figure F.) Solder the wires onto the board. Cut the extra wire off above the solder joint.

Figure C—Schematic diagram of a code-practice oscillator.

BRASS ROD SOLDERED IN POSITION

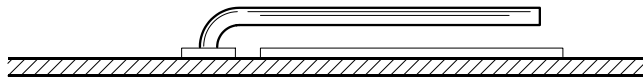

CIRCUIT-BOARD HANDLE

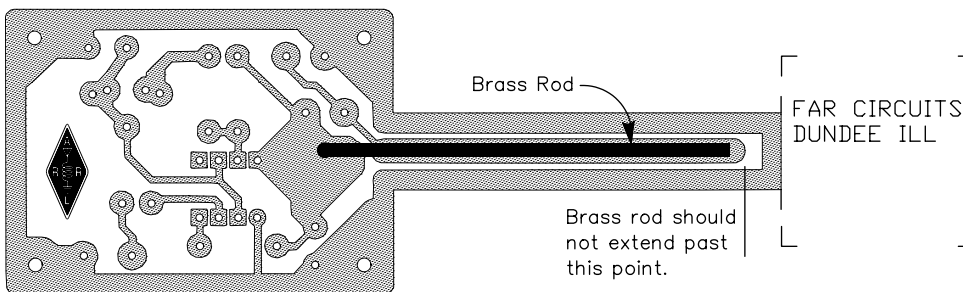
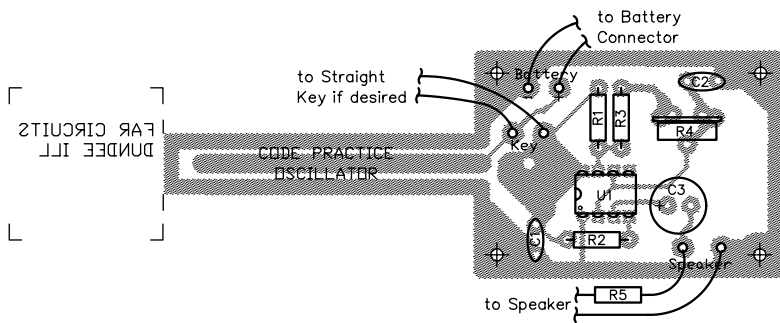
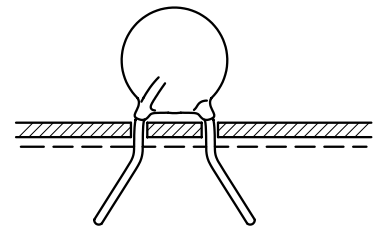

Figure D—Solder the brass rod in position on the foil side of the PC board. You can also use this figure as a circuit-board etching pattern if you want to make your own circuit board, since the pattern is printed full size.



**Figure E—Parts-placement diagram.**



**Figure F**

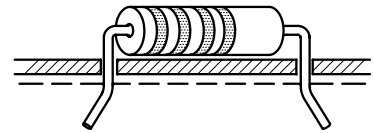

**Figure G**

**□ Step 7: Place R4 (100-kilohm potentiometer) on the component side of the circuit board.**

This component has three pins. All three pins must be plugged into the holes on the board. (It fits only one way.) Solder them in place and cut off any excess lead length.

**□ Step 8: Place R3 (47-kilohm resistor) on the component side of the circuit board.**

Bend the wires on the resistor to plug it into the board. (See Step 4 and Figure G.) Plug the resistor into the board, spread the wires and solder it in place. Trim off the extra wire lengths.

**□ Step 9: Place R1 (10-kilohm resistor) on the component side of the board.**

Bend the wires on the resistor to plug it into the board. (See Step 4 and Figure G.) Plug the resistor into the board, spread the wires and solder it in place. Trim the excess wire lengths.

**□ Step 10: Hook up the battery connector leads.**

The battery connector consists of two wires, one red and one black, attached to a snap-on cap. Remove  $\frac{1}{4}$  inch of plastic insulation from the end of both wires. The black wire is negative and the red wire is positive. The positive and negative battery connections are marked on the component side of the board. Be sure the red wire goes in the hole marked “+” and the black wire goes in the hole marked “-”. Solder the wires in place and trim any excess length close to the solder joint.

**□ Step 11: Hook up the speaker.**

If you are using the tie lug to hold the speaker in place, solder the speaker lugs to tie-point lugs on each side of the center post. (If you are not using the tie lug then you will solder the wires directly to the speaker lugs.) Cut the speaker wire into two equal lengths. Remove  $\frac{1}{4}$  inch of plastic insulation from each end of both wires. Solder one end of each wire to one of the tie-point solder lugs below the speaker terminals. Solder one end of R5 (47-ohm resistor) to the circuit board as shown in Figure E. Solder one wire to the other end of this resistor and the second speaker wire to the circuit board.

**□ Step 12: Attach the circuit board to the wood base.**

Place the completed circuit board on the wood. Trace through the four corner holes with a pencil. Take the circuit board off the wood and lay it aside. Place the spacers on the wood, standing upright. Carefully put the circuit board on top of the spacers. Put the  $\frac{3}{4}$ -inch screws through the holes in the circuit board and through the spacers and screw them into the board until snug. Be sure not to overtighten the screws, or you may crack the circuit board. Attach the speaker to the end of the board opposite the handle with a  $\frac{3}{8}$ -inch screw through the tie-point mounting hole, or mount the speaker to the board using two screws and holes in the outside edge of the speaker’s metal frame. Attach the U-shaped metal battery holder to the wooden base with a  $\frac{3}{8}$ -inch screw.

**□ Step 13: Plug the integrated circuit (IC) into the socket, being careful to position it so the notch or dot on one end of the IC is toward the handle.**

**CAUTION** — The static electricity from your body could destroy the IC. Before touching the IC, be sure you have discharged any static that may be built up on your body. While sitting at your table or workbench, touch a metal pipe or other large metal object for a few seconds. Carefully remove the IC from its foam padding. Hold it by the black body and avoid touching the wires. Plug it into the socket, being sure that the notched end of the IC is facing toward the handle. The notch on the IC should line up with the notch on the socket.

Attach the battery to the snap-on battery connector and place it in the U-shaped battery holder. This unit uses electricity only when the telegraph key handle is pushed down. No ON/OFF switch is necessary, and you may leave the battery connected at all times.

You’re done! The oscillator should produce a tone when you press the key. If your oscillator does not work, check all your connections carefully. Make sure the IC is positioned correctly in the socket, and that you have a fresh battery. If it still doesn’t work check all your solder connections.

Once you have the oscillator working, you’re ready to use it to practice Morse code. If you are studying with a friend, you can use the oscillator to send code to each other. If you are studying alone, tape record your sending and play it back later. Can you copy what you sent? How would it sound on the air? Good luck!